

A modular truss system with unlimited possibilities. Made in strong and durable materials: aluminum, steel and composite. Foldable construction - very easy to assemble and disassemble.

**Supplied complete with:**

- 24 x 120 cm Modules
- 8 x Corner Block,
- 12 x Connector Cross,
- 4 x Regular Base,
- 32 x Top and Bottom Clips,
- 8 x 120 cm Alu Profiles.

**SIDE 1**

14 x 120 cm

- 2 x
- 4 x
- 4 x

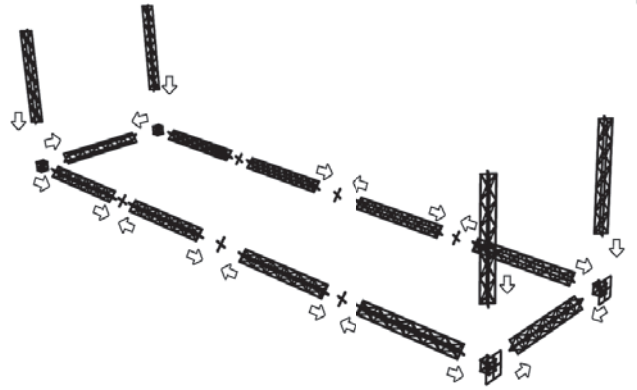

1

**SIDE 2**

10 x 120 cm

- 2 x
- 4 x
- 4 x

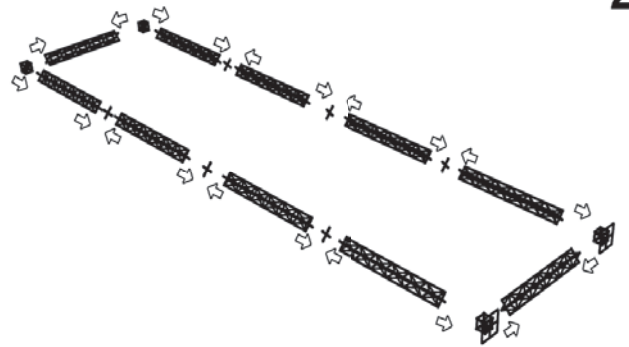

2

**ASSEMBLY**

Mount side 2 on top of side 1.

Install Banners before raising tower.

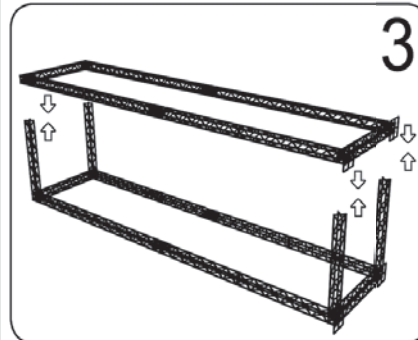

3

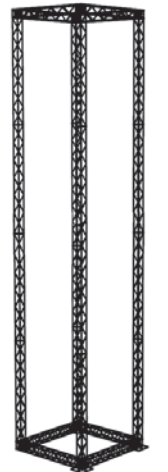

4

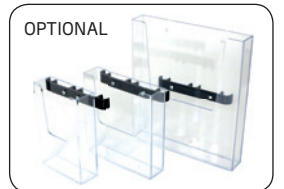
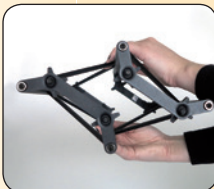
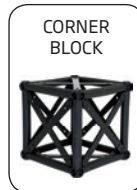
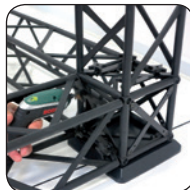

Art.no.	Print size	Colour	Total W x H x D	Package and weight
B1001900	4 pcs. 120 x 485 cm	Black	154 x 517 x 154 cm	3 pcs. cardboard box 79 kg